

# Operation Manual

Multi-CD control DSP High power CD Cassette player  
with FM/AM tuner

# FH-P6200

English

Español

한국어

**SUPER TUNER III** 

## Thank you for buying this Pioneer product.

Please read through these operating instructions so you will know how to operate your model properly. *After you have finished reading the instructions, put them away in a safe place for future reference.*

### 01 Before You Start

- About this manual 4
- Precautions 4
- About the demo mode 4
- Use and care of the remote control 4
  - Installing the batteries 4
  - Using the remote control 5
- Resetting the microprocessor 5
- Setting the display angle 5

### 02 What's What

- Head unit 7
- Remote control 8

### 03 Power ON/OFF

- Turning the unit on 9
- Selecting a source 9
- Turning the unit off 9

### 04 Tuner

- Listening to the radio 10
- Introduction of advanced tuner operation 11
- Storing and recalling broadcast frequencies 11
- Tuning in strong signals 11
- Storing the strongest broadcast frequencies 12

### 05 Cassette Player

- Playing a tape 13
- Introduction of advanced cassette player operation 14
- Repeating play 15
- Skipping blank tape sections 15
- Using Dolby noise reduction 15

### 06 Built-in CD Player

- Playing a CD 16

- Introduction of advanced built in CD player operation 17
- Repeating play 17
- Playing tracks in a random order 18
- Scanning tracks of a CD 18
- Pausing CD playback 18
- Using disc title functions 19
  - Entering disc titles 19
  - Displaying disc titles 19
- Using CD TEXT functions 20
  - Displaying titles on CD TEXT discs 20
  - Scrolling titles in the display 20

### 07 Multi-CD Player

- Playing a CD 21
- 50 disc multi CD player 21
- Introduction of advanced multi CD player operation 22
- Repeating play 22
- Playing tracks in a random order 22
- Scanning CDs and tracks 23
- Pausing CD playback 23
- Using ITS playlists 23
  - Creating a playlist with ITS programming 23
  - Playback from your ITS playlist 24
  - Erasing a track from your ITS playlist 24
  - Erasing a CD from your ITS playlist 25
- Using disc title functions 25
  - Entering disc titles 25
  - Displaying disc titles 26
  - Selecting discs from the disc title list 26
- Using CD TEXT functions 26
  - Displaying titles on CD TEXT discs 26

- Scrolling titles in the display **26**
- Using compression and bass emphasis **27**

## 08 Audio Adjustments

- Introduction of audio adjustments **28**
- Using balance adjustment **28**
- Adjusting loudness **29**
- Using subwoofer output **29**
  - Adjusting subwoofer (low pass filter) settings **29**
  - Adjusting low pass filter attenuation slope **29**
- Using the high pass filter **30**
  - Adjusting high pass filter attenuation slope **30**
- Using non fading output **30**
  - Adjusting non fading output level **30**
- Adjusting source levels **31**

## 09 Digital Signal Processor

- Using the digital signal processor **32**
- Using sound field control and BBE sound **32**
  - Recalling sound field programs **33**
  - Adjusting BBE sound level **33**
- Using the graphic equalizer **33**
  - Recalling equalizer curves **33**
  - Adjusting equalizer curves **34**
  - Adjusting 9 band graphic equalizer **34**
- Using the position selector **34**
- Using automatic sound levelizer **35**

## 10 Initial Settings

- Adjusting initial settings **36**
- Setting the clock **36**
- Setting the FM tuning step **36**
- Setting the AM tuning step **37**
- Switching the auxiliary setting **37**

- Switching the dimmer setting **37**
- Switching the RCA output setting **37**
- Selecting the digital attenuator **38**
- Adjusting display contrast **38**
- Switching the telephone muting/attenuation **38**

## 11 Other Functions

- Turning the clock display on or off **39**
- Switching the display color **39**
  - Adjusting the display color **39**
- Using different entertainment displays **39**
- Using the AUX source **39**
  - Selecting AUX as the source **40**
  - Setting the AUX title **40**

## Additional Information

- Understanding built in CD player error messages **41**
- Cassette tapes **41**
- Cleaning the playback head **41**
- Music search and repeat functions during tape playback **41**
- CD player and care **42**
- CD R/CD RW discs **42**
- Specifications **43**

## About this manual

This unit features a number of sophisticated functions ensuring superior reception and operation. All the functions have been designed for the easiest possible use, but many are not self explanatory. This operation manual will help you benefit fully from this product's potential and to maximize your listening enjoyment.

We recommend that you familiarize yourself with the functions and their operation by reading through the manual before you begin using this unit. It is especially important that you read and observe precautions on this page and in other sections. ▣

## Precautions

**CAUTION:**  
**USE OF CONTROL OR ADJUSTMENT OR PERFORMANCE OF PROCEDURES OTHER THAN THOSE SPECIFIED HEREIN MAY RESULT IN HAZARDOUS RADIATION EXPOSURE.**

**CAUTION:**  
**THE USE OF OPTICAL INSTRUMENTS WITH THIS PRODUCT WILL INCREASE EYE HAZARD.**

- Keep this manual handy as a reference for operating procedures and precautions.
- Always keep the volume low enough so you can hear sounds outside of the car.
- Protect this product from moisture.
- If the battery is disconnected or discharged, the preset memory will be erased and must be reprogrammed.
- If this unit does not operate properly, contact your dealer or nearest authorized Pioneer Service Station. ▣

## About the demo mode

The demonstration automatically starts when power to this unit is turned off while the ignition switch is set to ACC or ON. Pressing **6** numbered button during demonstration cancels the demonstration. Pressing **6** numbered button again to start the demonstration. Remember that if the demonstration continues operating when the car engine is turned off, it may drain battery power.



### Important

The red lead (ACC) of this unit should be connected to a terminal coupled with ignition switch on/off operations. If this is not done, the vehicle battery may be drained. ▣

## Use and care of the remote control

### Installing the batteries

Remove the cover on the back of the remote control and insert the batteries with the plus (+) and minus (-) poles pointing in the proper direction.

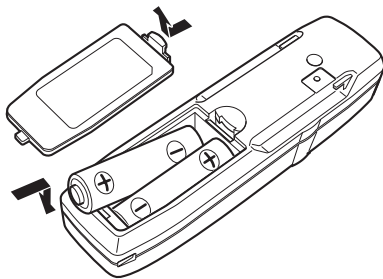

### CAUTION

- Use only **AAA** or **IEC R03 (1.5 V)** batteries.

## Before You Start

- Remove the batteries if the remote control is not used for a month or longer.
- Do not attempt to recharge the supplied batteries.
- Do not mix new and used batteries.
- If the event of battery leakage, wipe the remote control completely clean and install new batteries.
- When disposing of used batteries, please comply with governmental regulations or environmental public institution's rules that apply in your country/area.

## Using the remote control

Point the remote control in the direction of the front panel to operate.

### Important

- Do not store the remote control in high temperatures or direct sunlight.
- The remote control may not function properly in direct sunlight.
- Do not let the remote control fall onto the floor, where it may become jammed under the brake or accelerator pedal.
- When the remote control is not in use, attach it firmly to the provided mounting base.
- If you press **FUNCTION** on the remote control while pressing **BAND** at the same time, the remote control will not function properly. To cancel this setting, press **AUDIO** on the remote control while pressing **BAND** at the same time to return to the previous setting. 

## Resetting the microprocessor

The microprocessor must be reset under the following conditions:

- Prior to using this unit for the first time after installation
- If the unit fails to operate properly

- When strange or incorrect messages appear on the display

- **Press RESET on the head unit with a pen tip or other pointed instrument.**

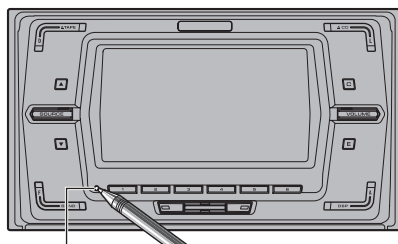

RESET button



## Setting the display angle

You can adjust front panel angle for easier operation.

### WARNING

- Do not use with the front panel left open. If you do leave it open, it may result in injury in the event of an accident.
- Be careful not to catch your finger in the front panel when it is opening or closing.

- **Press ANGLE to change the angle.** Each press of **ANGLE** changes the angle.

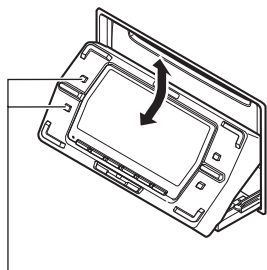

**ANGLE** button



### Notes

- While a disc or a cassette is left partially inserted, you cannot operate the angle.
- By pressing **ANGLE** and hold, you can open or close the front panel.

## What's What

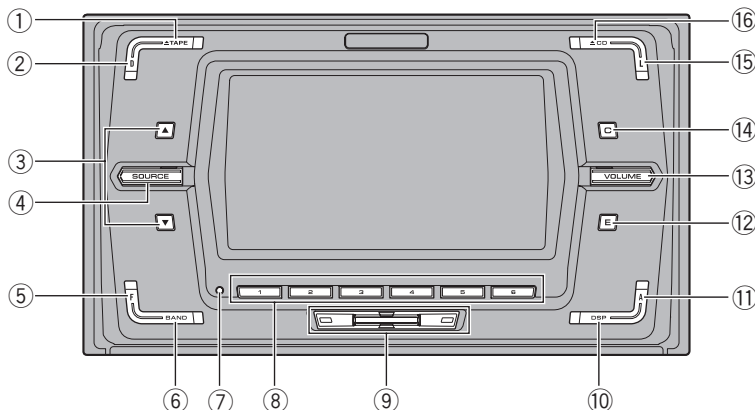

### Head unit

#### ① TAPE EJECT button

Press to eject a tape from your cassette player.

#### ② DISPLAY button

Press to select different displays.

#### ③ ANGLE button

Press to change the display angle.

#### ④ SOURCE button

This unit is turned on by selecting a source. Press upward or downward to cycle through all of the available sources.

#### ⑤ FUNCTION button

Press to select functions.

#### ⑥ BAND button

Press to select among three FM and one AM bands and cancel the control mode of functions.

#### ⑦ RESET button

Press to reset the microprocessor.

#### ⑧ 1-6 buttons

Press for preset tuning and disc number search when using a multi CD player.

#### ⑨ ▲/▼/◀/▶ buttons

Press to do manual seek tuning, fast forward, reverse and track search controls. Also used for controlling functions.

#### ⑩ DSP button

Press to select sound field functions.

#### ⑪ AUDIO button

Press to select various sound quality controls.

#### ⑫ ENTERTAINMENT button

Press to change to the entertainment display.

#### ⑬ VOLUME button

Press upward to increase the volume and press downward to lower the volume.

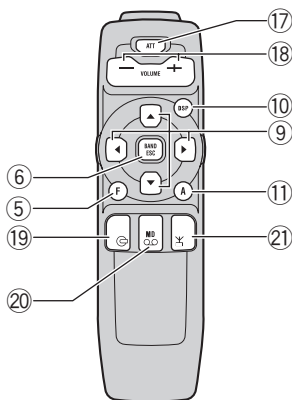

#### 14 COLOR button

Press to change the back light color of the display.

#### 15 LOUD button

Press to turn loudness on or off.  
Press and hold to change to the clock display.

#### 16 CD EJECT button

Press to eject a CD from your built in CD player.

## Remote control

Operation is the same as when using the button on the head unit.

#### 17 ATT button

Press to quickly lower the volume level, by about 90%. Press once more to return to the original volume level.

#### 18 VOLUME button

Press to increase or decrease the volume.

#### 19 CD button

Press to select the built in or multi CD player as the source.

#### 20 CASSETTE button

Press to select the cassette player as the source.

#### 21 TUNER button

Press to select the tuner as the source.



## Power ON/OFF

### Turning the unit on

- Press **SOURCE** on the head unit upward or downward, or press **TUNER, CASSETTE** or **CD** on the remote, to turn the unit on.

When you select a source the unit is turned on. 

### Selecting a source

You can select a source you want to listen to. To switch to the built in CD player, load a disc in this unit (refer to page 16). To switch to the cassette player, load a cassette tape in this unit (refer to page 13).

- 1 When using the head unit, press **SOURCE** upward or downward to select a source.

Press **SOURCE** repeatedly to switch between the following sources:

**Built-in CD player—Television—Tuner—Cassette player—Multi-CD player—External unit 1—External unit 2—AUX—Sources off**

- 2 When using the remote control, press **TUNER, CASSETTE** or **CD** to select a source.

Press each button repeatedly to switch between the following sources:

**TUNER: Television—Tuner—Sources off**  
**CASSETTE: Cassette player—AUX—Sources off**  
**CD: Built-in CD player—Multi-CD player—Sources off**



#### Notes

- In the following cases, the sound source will not change:
  - When a unit corresponding to each source is not connected to this unit.
  - When no disc is set in this unit.
  - When no cassette is set in this unit.

- When no magazine is set in the multi CD player.
- When the AUX (auxiliary input) is set to off (refer to page 37).
- External unit refers to a Pioneer product (such as one available in the future) that, although incompatible as a source, enables control of basic functions by this unit. Two external units can be controlled by this unit. When two external units are connected, the allocation of them to external unit 1 or external unit 2 is automatically set by this unit.
- When this unit's blue lead is connected to the car's auto antenna relay control terminal, the car's antenna extends when this unit's selected source is the tuner. To retract the antenna, switch to a source other than tuner. 

### Turning the unit off

- Press **SOURCE** on the head unit upward or downward repeatedly to turn the unit off.

When using the remote control, press **TUNER, CASSETTE** or **CD** repeatedly. 

## Listening to the radio

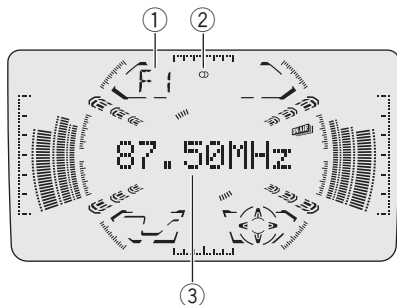

These are the basic steps necessary to operate the radio. More advanced tuner operation is explained starting on the next page.



### Important

If you are using this unit in North, Central or South America, reset the AM tuning step (see *Setting the AM tuning step* on page 37).

#### ① Band indicator

Shows which band the radio is tuned to, AM or FM.

#### ② Stereo (Ⓞ) indicator

Shows that the frequency selected is being broadcast in stereo.

#### ③ Frequency indicator

Shows to which frequency the tuner is tuned.

### 1 Press SOURCE upward or downward to select the tuner.

Press **SOURCE** until you see **Tuner** displayed.

### 2 Use VOLUME to adjust the sound level.

Press **VOLUME** on the head unit upward to increase the volume, and press downward to lower the volume.

### 3 Press BAND to select a band.

Press **BAND** until the desired band is displayed, **F1**, **F2**, **F3** for FM or **AM**.

### 4 To perform manual tuning, press ◀ or ▶ with quick presses.

The frequencies move up or down step by step.

### 5 To perform seek tuning, press and hold ◀ or ▶ for about one second and release.

The tuner will scan the frequencies until a broadcast strong enough for good reception is found.

- You can cancel seek tuning by pressing either ◀ or ▶ with a quick press.
- If you press and hold ◀ or ▶ you can skip broadcasting stations. Seek tuning starts as soon as you release the buttons.



### Note

When the frequency selected is being broadcast in stereo the stereo (Ⓞ) indicator will light.

## Introduction of advanced tuner operation

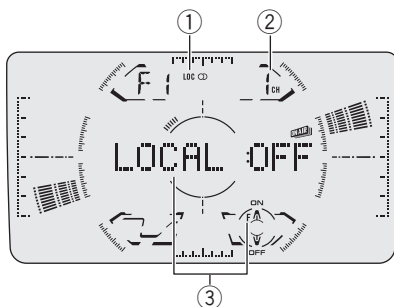

- ① **LOC indicator**  
Shows when local seek tuning is on.
- ② **Preset number indicator**  
Shows what preset has been selected.
- ③ **Function display**  
Shows the function status.

- **Press FUNCTION to display the function names.**

Press **FUNCTION** repeatedly to switch between the following functions:  
**BSM** (best stations memory)—**LOCAL** (local seek tuning)

- To return to the frequency display, press **BAND**.

- **Note**

If you do not operate the function within about 30 seconds, the display is automatically returned to the frequency display. 

## Storing and recalling broadcast frequencies

If you press any of the preset tuning buttons **1–6** you can easily store up to six broadcast frequencies for later recall with the touch of a button.

- **When you find a frequency that you want to store in memory press a preset tuning button 1–6 and hold until the preset number stops flashing.**

The number you have pressed will flash in the preset number indicator and then remain lit. The selected radio station frequency has been stored in memory.

The next time you press the same preset tuning button **1–6** the radio station frequency is recalled from memory.



### Notes

- Up to 18 FM stations, 6 for each of the three FM bands, and 6 AM stations can be stored in memory.
- You can also use **▲** and **▼** to recall radio station frequencies assigned to preset tuning buttons **1–6**. 

## Tuning in strong signals

Local seek tuning lets you tune in only those radio stations with sufficiently strong signals for good reception.

### 1 Press FUNCTION to select LOCAL.

Press **FUNCTION** until **LOCAL** appears in the display.

### 2 Press ▲ to turn local seek tuning on.

Local seek sensitivity (e.g., **LOCAL 2**) appears in the display.

### 3 Press ◀ or ▶ to set the sensitivity.

There are four levels of sensitivity for FM and two levels for AM:

FM: **LOCAL 1—LOCAL 2—LOCAL 3—**

**LOCAL 4**

AM: **LOCAL 1—LOCAL 2**

The **LOCAL 4** setting allows reception of only the strongest stations, while lower settings let you receive progressively weaker stations.

### 4 When you want to return to normal seek tuning, press ▼ to turn local seek tuning off.

**LOCAL:OFF** appears in the display. ◻

## Storing the strongest broadcast frequencies

BSM (best stations memory) lets you automatically store the six strongest broadcast frequencies under preset tuning buttons **1–6** and once stored there you can tune in to those frequencies with the touch of a button.

### 1 Press FUNCTION to select BSM.

Press **FUNCTION** until **BSM** appears in the display.

### 2 Press ▲ to turn BSM on.

**BSM** begins to flash. While **BSM** is flashing the six strongest broadcast frequencies will be stored under preset tuning buttons **1–6** in order of their signal strength. When finished, **BSM** stops flashing.

- To cancel the storage process, press ▼.



#### Note

Storing broadcast frequencies with BSM may replace broadcast frequencies you have saved using **1–6**. ◻

# Cassette Player

## Playing a tape

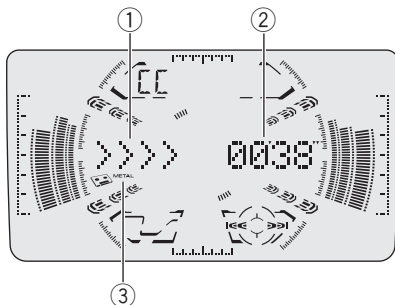

These are the basic steps necessary to play a tape with your cassette player. More advanced cassette player operation is explained starting on the next page.

### **!** WARNING

Do not use with the front panel left open, after ejecting a cassette tape. If you do leave it open, it may result in injury in the event of an accident.

#### ① **Tape direction indicator**

Shows the direction of the tape transport.

#### ② **Play time indicator**

Shows the elapsed playing time of the current side of the tape.

#### ③ **METAL indicator**

Shows when a metal or chrome tape is inserted.

### 1 **Press TAPE EJECT.**

Cassette loading slot appears.

- After a cassette tape has been inserted, press **SOURCE** upward or downward to select the cassette player.

### 2 **Insert a cassette tape into the cassette loading slot.**

Front panel is closed automatically, and play back will start.

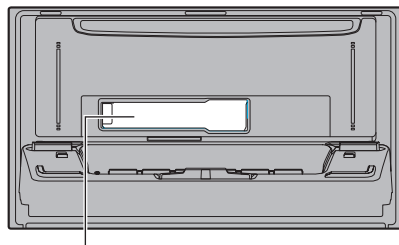

Cassette loading slot

- You can eject a cassette tape by pressing **TAPE EJECT**.

### 3 **Use VOLUME to adjust the sound level.**

Press **VOLUME** on the head unit upward to increase the volume, and press downward to lower the volume.

### 4 **To perform fast forward or rewind, press ◀ or ▶.**

**FF** or **REW** appears in the display.

- To cancel fast forward or rewind and return to playback, press **BAND**.
- You can cancel fast forward or rewind by pressing ◀ or ▶ in the same direction twice.

### 5 **To perform forward or rewind music search, press ◀ or ▶ twice.**

**F-MS** (forward music search) or **R-MS** (rewind music search) appears in the display. The cassette player will fast forward or rewind to the next or previous blank spot on the tape and begin to play.

- To cancel music search and return to play back, press **BAND**.
- You can cancel music search by pressing ◀ or ▶ in the same direction again.

### 6 **To change the direction of the tape transport, press BAND.**

### Notes

- Do not insert anything other than a cassette tape into the cassette loading slot.
- A cassette left partially inserted after ejection may incur damage or fall out.
- Play time indicator starts from **00'00"** in the following cases:
  - When a tape is inserted
  - When the tape direction is changed
  - When you rewind the tape to the beginning
- Play time indicator is halted when fast forward, rewind or music search is operating. 

## Introduction of advanced cassette player operation

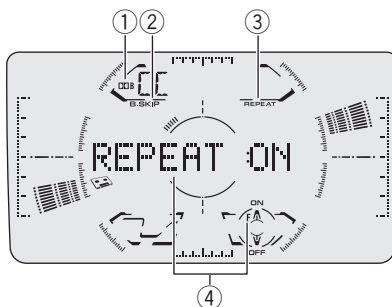

- ① **Dolby B NR indicator**  
Shows when Dolby B NR is turned on.
- ② **B.SKIP indicator**  
Shows when blank skip is turned on.
- ③ **REPEAT indicator**  
Shows when repeat play is turned on.
- ④ **Function display**  
Shows the function status.

### ● Press **FUNCTION** to display the function names.

Press **FUNCTION** repeatedly to switch between the following functions:

**REPEAT** (repeat play)—**B.SKIP** (blank skip)  
—**NR** (Dolby B NR)

- To return to the playback display, press **BAND**.

### Note

If you do not operate the function within about 30 seconds, the display is automatically returned to the playback display. 

## Cassette Player

### Repeating play

Repeat play lets you hear the same track over again.

#### 1 Press **FUNCTION** to select **REPEAT**.

Press **FUNCTION** until **REPEAT** appears in the display.

#### 2 Press **▲** to turn repeat play on.

**REPEAT:ON** appears in the display. The track currently playing will play and then repeat.

#### 3 Press **▼** to turn repeat play off.

**REPEAT:OFF** appears in the display. The track currently playing will continue to play and then play the next track. 

### Skipping blank tape sections

Blank skip automatically fast forwards to the next song if there is a long period of silence (12 seconds or longer) between songs.

#### 1 Press **FUNCTION** to select **B.SKIP**.

Press **FUNCTION** until **B.SKIP** appears in the display.

#### 2 Press **▲** to turn blank skip on.

**B.SKIP:ON** appears in the display. Long periods of silence between songs will be skipped.

#### 3 Press **▼** to turn blank skip off.

**B.SKIP:OFF** appears in the display. The complete cassette tape will play. 

### Using Dolby noise reduction

When you listen to tapes that have been recorded with Dolby B NR, turn Dolby B NR on.

#### 1 Press **FUNCTION** to select **NR**.

Press **FUNCTION** until **NR** appears in the display.

#### 2 Press **▲** to turn Dolby B NR on.

**B NR:ON** appears in the display. The tape will play with Dolby B NR on.

#### 3 Press **▼** to turn Dolby B NR off.

**NR:OFF** appears in the display. The tape will play without Dolby B NR.



#### Note

Manufactured under license from Dolby Laboratories. "Dolby" and the double D symbol are trademarks of Dolby Laboratories. 

## Playing a CD

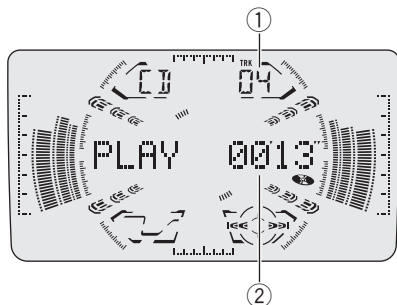

These are the basic steps necessary to play a CD with your built in CD player. More advanced CD operation is explained starting on the next page.

### **!** WARNING

Do not use with the front panel left open, after ejecting a CD. If you do leave it open, it may result in injury in the event of an accident.

#### ① Track number indicator

Shows the track currently playing.

#### ② Play time indicator

Shows the elapsed playing time of the current track.

### 1 Press **CD EJECT**.

CD loading slot appears.

- After a CD has been inserted, press **SOURCE** upward or downward to select the built in CD player.

### 2 Insert a CD into the CD loading slot.

Front panel is closed automatically, and play back will start.

CD loading slot

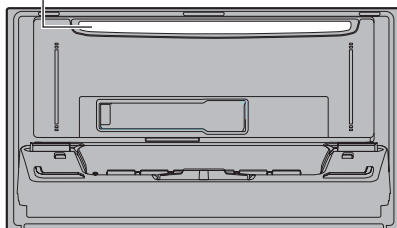

- You can eject a CD by pressing **CD EJECT**.

### 3 Use **VOLUME** to adjust the sound level.

Press **VOLUME** on the head unit upward to increase the volume, and press downward to lower the volume.

### 4 To perform fast forward or reverse, press and hold **◀** or **▶**.

### 5 To skip back or forward to another track, press **◀** or **▶**.

Pressing **▶** skips to the start of the next track. Pressing **◀** once skips to the start of the current track. Pressing again will skip to the previous track.



### Notes

- The built in CD player plays one, standard, 12 cm or 8 cm (single) CD at a time. Do not use an adapter when playing 8 cm CDs.
- Do not insert anything other than a CD into the CD loading slot.
- A CD left partially inserted after ejection may incur damage or fall out.
- If you cannot insert a disc completely or if after you insert a disc the disc does not play, check that the label side of the disc is up. Press **CD EJECT** to eject the disc, and check the disc for damage before inserting the disc again.
- If the built in CD player does not operate properly, an error message such as **CD ERR-11**



## Built-in CD Player

may be displayed. Refer to *Understanding built in CD player error messages* on page 41.

- You can eject the CD by pressing and holding **CD EJECT** with opening the front panel when the CD loading or ejecting cannot operate properly.
- When a CD TEXT disc is inserted, the disc and track titles begin to scroll to the left automatically. 

## Introduction of advanced built-in CD player operation

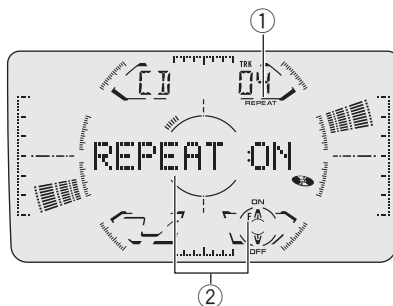

### ① REPEAT indicator

Shows when repeat play is turned on.

### ② Function display

Shows the function status.

### ● Press **FUNCTION** to display the function names.

Press **FUNCTION** repeatedly to switch between the following functions:

**REPEAT** (repeat play)—**RANDOM** (random play)—**T.SCAN** (scan play)—**PAUSE** (pause)

- To return to the playback display, press **BAND**.



### Note

If you do not operate the function within about 30 seconds, the display is automatically returned to the playback display. 

## Repeating play

Repeat play lets you hear the same track over again.

## Built-in CD Player

### 1 Press **FUNCTION** to select **REPEAT**.

Press **FUNCTION** until **REPEAT** appears in the display.

### 2 Press **▲** to turn repeat play on.

**REPEAT:ON** appears in the display. The track currently playing will play and then repeat.

### 3 Press **▼** to turn repeat play off.

**REPEAT:OFF** appears in the display. The track currently playing will continue to play and then play the next track.



#### Note

If you perform track search or fast forward/reverse, repeat play is automatically cancelled. 

## Playing tracks in a random order

Random play lets you play back tracks on the CD in a random order.

### 1 Press **FUNCTION** to select **RANDOM**.

Press **FUNCTION** until **RANDOM** appears in the display.

### 2 Press **▲** to turn random play on.

**RANDOM:ON** appears in the display. Tracks will play in a random order.

### 3 Press **▼** to turn random play off.

**RANDOM:OFF** appears in the display. Tracks will continue to play in order. 

## Scanning tracks of a CD

Scan play lets you hear the first 10 seconds of each track on the CD.

### 1 Press **FUNCTION** to select **T.SCAN**.

Press **FUNCTION** until **T.SCAN** appears in the display.

### 2 Press **▲** to turn scan play on.

**T.SCAN:ON** appears in the display. The first 10 seconds of each track is played.

### 3 When you find the desired track press **▼** to turn scan play off.

**T.SCAN:OFF** appears in the display. The track will continue to play.

- If the display has automatically returned to the playback display, select **T.SCAN** again by pressing **FUNCTION**.



#### Note

After scanning of a CD is finished, normal play back of the tracks will begin again. 

## Pausing CD playback

Pause lets you temporarily stop playback of the CD.

### 1 Press **FUNCTION** to select **PAUSE**.

Press **FUNCTION** until **PAUSE** appears in the display.

### 2 Press **▲** to turn pause on.

**PAUSE:ON** appears in the display. Play of the current track pauses.

### 3 Press **▼** to turn pause off.

**PAUSE:OFF** appears in the display. Play will resume at the same point that you turned pause on. 

## Built-in CD Player

### Using disc title functions

You can input CD titles and display the title. The next time you insert a CD for which you have entered a title, the title of that CD will be displayed.

### Entering disc titles

Disc title input lets you input CD titles up to 10 letters long and up to 48 disc titles into the built in CD player.

#### 1 Play a CD that you want to enter the title.

#### 2 Press **FUNCTION** and hold until **TITLE IN** appears in the display.

■ When playing a CD **TEXT** disc, you cannot switch to **TITLE IN**. The disc title will have already been recorded on a CD **TEXT** disc.

#### 3 Press **1** numbered button to select the desired character type.

Press **1** numbered button repeatedly to switch between the following character type:

Alphabet (upper case), numbers and symbols — Alphabet (lower case)

■ You can select to input numbers and symbols by pressing **2** numbered button.

#### 4 Press **▲** or **▼** to select a letter of the alphabet.

Each press of **▲** will display a letter of the alphabet in **A B C ... X Y Z**, numbers and symbols in **1 2 3 ... @ # <** order. Each press of **▼** will display a letter in the reverse order, such as **Z Y X ... C B A** order.

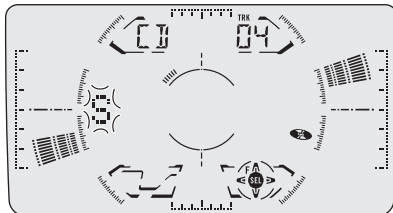

#### 5 Press **▶** to move the cursor to the next character position.

When the letter you want is displayed, press **▶** to move the cursor to the next position and then select the next letter. Press **◀** to move backwards in the display.

#### 6 Move the cursor to the last position by pressing **▶** after entering the title.

When you press **▶** one more time, the entered title is stored in memory.

#### 7 Press **BAND** to return to the playback display.



#### Notes

- Titles remain in memory, even after the disc has been removed from built in CD player, and are recalled when the disc is reinserted.
- After data for 48 discs has been stored in memory, data for a new disc will overwrite the oldest one.
- If you connect a multi CD player, you can input disc titles for up to 100 discs.

### Displaying disc titles

You can display the title of any disc that has had a disc title entered.

#### ● Press **DISPLAY**.

Press **DISPLAY** repeatedly to switch between the following settings:

Play time—**DISC TITLE** (disc title)

When you select **DISC TITLE**, the title of the currently playing disc is shown in the display.

- If no title has been entered for the currently playing disc, **NO TITLE** is displayed.

## Using CD TEXT functions

Some discs have certain information encoded on the disc during manufacture. These discs may contain such information as the CD title, track title, artist's name and playback time and are called CD TEXT discs. Only these specially encoded CD TEXT discs support the functions listed below.

### Displaying titles on CD TEXT discs

- **Press DISPLAY.**

Press **DISPLAY** repeatedly to switch between the following settings:

Play time—**DISC TITLE** (disc title)—**D.ARTIST**  
(disc artist name)—**TRK TITLE** (track title)  
—**T.ARTIST** (track artist name)

- If specific information has not been recorded on a CD TEXT disc, **NO XXXX** will be displayed (e.g., **NO TA-NAME**).

### Scrolling titles in the display

This unit can display the first 10 letters only of **DISC TITLE**, **D.ARTIST**, **TRK TITLE** and **T.ARTIST**. When the recorded information is longer than 10 letters, you can scroll the text to the left so that the rest of the title can be seen.

- **Press DISPLAY and hold until the title begins to scroll to the left.**

The rest of the title will appear in the display.

## Multi-CD Player

### Playing a CD

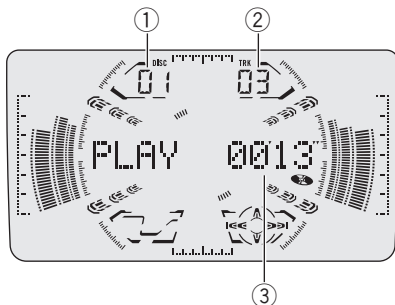

You can use this unit to control a multi CD player, which is sold separately.

These are the basic steps necessary to play a CD with your multi CD player. More advanced CD operation is explained starting on the next page.

#### ① Disc number indicator

Shows the disc currently playing.

#### ② Track number indicator

Shows the track currently playing.

#### ③ Play time indicator

Shows the elapsed playing time of the current track.

#### 1 Press SOURCE upward or downward to select the multi-CD player.

Press **SOURCE** until you see **Multi-CD** displayed.

#### 2 Use VOLUME to adjust the sound level.

Press **VOLUME** on the head unit upward to increase the volume, and press downward to lower the volume.

#### 3 Select a disc you want to listen to with the 1–6 buttons.

For discs located at 1 to 6, press the corresponding number button.

If you want to select a disc located at 7 to 12, press and hold the corresponding numbers such as **1** for disc 7, until the disc number appears in the display.

- You can also sequentially select a disc by pressing **▲/▼**.

#### 4 To perform fast forward or reverse, press and hold ◀ or ▶.

#### 5 To skip back or forward to another track, press ◀ or ▶.

Pressing **▶** skips to the start of the next track.

Pressing **◀** once skips to the start of the current track. Pressing again will skip to the previous track.



#### Notes

- When the multi CD player performs the preparatory operations, **READY** is displayed.
- If the multi CD player does not operate properly, an error message such as **CD ERR-11** may be displayed. Refer to the multi CD player owner's manual.
- If there are no discs in the multi CD player magazine, **NO DISC** is displayed.
- When you select a CD TEXT disc on a CD TEXT compatible multi CD player, the disc and track titles begin to scroll to the left automatically.

### 50-disc multi-CD player

Only those functions described in this manual are supported for 50 disc multi CD players.

## Introduction of advanced multi-CD player operation

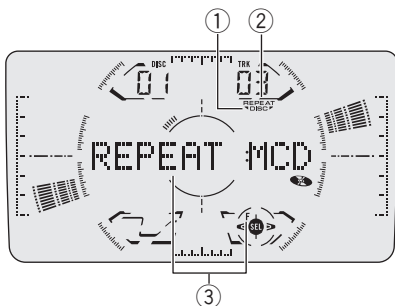

### ① DISC indicator

Shows when repeat range is selected to current disc.

### ② REPEAT indicator

Shows when repeat range is selected to current track.

### ③ Function display

Shows the function status.

### ● Press FUNCTION to display the function names.

Press **FUNCTION** repeatedly to switch between the following functions:

**REPEAT** (repeat play)—**TITLE LIST** (disc title list)—**RANDOM** (random play)—**SCAN** (scan play)—**ITS.P** (ITS play)—**PAUSE** (pause)—**COMP** (compression and DBE)

- To return to the playback display, press **BAND**.

### Note

If you do not operate the function within about 30 seconds, the display is automatically returned to the playback display. 

## Repeating play

There are three repeat play ranges for the multi CD player: **MCD** (multi CD player repeat), **TRK** (one track repeat) and **DSC** (disc repeat).

### 1 Press FUNCTION to select REPEAT.

Press **FUNCTION** until **REPEAT** appears in the display.

### 2 Press ◀ or ▶ to select the repeat range.

Press ◀ or ▶ until the desired repeat range appears in the display.

- **MCD** – Repeat all discs in the multi CD player
- **TRK** – Repeat just the current track
- **DSC** – Repeat the current disc

### Notes

- If you select other discs during repeat play, the repeat play range changes to **MCD**.
- If you perform track search or fast forward/reverse during **TRK**, the repeat play range changes to **DSC**. 

## Playing tracks in a random order

Random play lets you play back tracks in a random order within the repeat range, **MCD** and **DSC**.

### 1 Select the repeat range.

Refer to *Repeating play* on this page.

### 2 Press FUNCTION to select RANDOM.

Press **FUNCTION** until **RANDOM** appears in the display.

## Multi-CD Player

### 3 Press ▲ to turn random play on.

**RANDOM :ON** appears in the display. Tracks will play in a random order within the previously selected **MCD** or **DSC** ranges.

### 4 Press ▼ to turn random play off.

**RANDOM :OFF** appears in the display. Tracks will continue to play in order. 

## Scanning CDs and tracks

While you are using **DSC**, the beginning of each track on the selected disc plays for about 10 seconds. When you are using **MCD**, the beginning of the first track of each disc is played for about 10 seconds.

### 1 Select the repeat range.

Refer to *Repeating play* on the previous page.

### 2 Press FUNCTION to select SCAN.

Press **FUNCTION** until **SCAN** appears in the display.

### 3 Press ▲ to turn scan play on.

**SCAN :ON** appears in the display. The first 10 seconds of each track of the current disc (or the first track of each disc) is played.

### 4 When you find the desired track (or disc) press ▼ to turn scan play off.

**SCAN :OFF** appears in the display. The track (or disc) will continue to play.

- If the display has automatically returned to the playback display, select **SCAN** again by pressing **FUNCTION**.



#### Note

After track or disc scanning is finished, normal playback of the tracks will begin again. 

## Pausing CD playback

Pause lets you temporarily stop playback of the CD.

### 1 Press FUNCTION to select PAUSE.

Press **FUNCTION** until **PAUSE** appears in the display.

### 2 Press ▲ to turn pause on.

**PAUSE :ON** appears in the display. Play of the current track pauses.

### 3 Press ▼ to turn pause off.

**PAUSE :OFF** appears in the display. Play will resume at the same point that you turned pause on. 

## Using ITS playlists

ITS (instant track selection) lets you make a playlist of favorite tracks from those in the multi CD player magazine. After you have added your favorite tracks to the playlist you can turn on ITS play and play just those selections.

## Creating a playlist with ITS programming

You can use ITS to enter and playback up to 99 tracks per disc, up to 100 discs (with the disc title). (With multi CD players sold before the CDX P1250 and CDX P650, up to 24 tracks can be stored in the playlist.)

### 1 Play a CD that you want to program.

Press ▲ or ▼ to select a CD.

**2 Press FUNCTION and hold until TITLE IN appears in the display, then press FUNCTION to select ITS.**

After **TITLE IN** is displayed, press **FUNCTION** repeatedly, the following functions appear in the display:

**TITLE IN** (disc title input)—**ITS** (ITS programming)

**3 Select a desired track by pressing ◀ or ▶.**

**4 Press ▲ to store the currently playing track in the playlist.**

**ITS IN** is displayed briefly and the currently playing selection is added to your playlist. The display then shows **ITS** again.

**5 Press BAND to return to the playback display.**



#### Note

After data for 100 discs has been stored in memory, data for a new disc will overwrite the oldest one.

## Playback from your ITS playlist

ITS play lets you listen to the tracks that you have entered into your ITS playlist. When you turn on ITS play, tracks from your ITS playlist in the multi CD player will begin to play.

**1 Select the repeat range.**

Refer to *Repeating play* on page 22.

**2 Press FUNCTION to select ITS.P.**

Press **FUNCTION** until **ITS.P** appears in the display.

**3 Press ▲ to turn ITS play on.**

**ITS.P:ON** appears in the display. Playback begins of those tracks from your playlist within the previously selected **MCD** or **DSC** ranges.

▪ If no tracks in the current range are programmed for ITS play then **ITS EMPTY** is displayed.

**4 Press ▼ to turn ITS play off.**

**ITS.P:OFF** appears in the display. Playback will continue in normal order from the currently playing track and CD.

## Erasing a track from your ITS playlist

When you want to delete a track from your ITS playlist, you can if ITS play is on.

If ITS play is already on, skip to step 2. If ITS play is not already on, press **FUNCTION**.

**1 Play a CD you want to delete a track from your ITS playlist, and turn ITS play on.**

Refer to *Playback from your ITS playlist* on this page.

**2 Press FUNCTION and hold until TITLE IN appears in the display, then press FUNCTION to select ITS.**

After **TITLE IN** is displayed, press **FUNCTION** until **ITS** appears in the display.

**3 Select a desired track by pressing ◀ or ▶.**

**4 Press ▼ to erase a track from your ITS playlist.**

The currently playing selection is erased from your ITS playlist and playback of the next track from your ITS playlist begins.

▪ If there are no tracks from your playlist in the current range, **ITS EMPTY** is displayed and normal play resumes.

**5 Press BAND to return to the playback display.**



## Multi-CD Player

### Erasing a CD from your ITS playlist

When you want to delete all tracks of a CD from your ITS playlist, you can if ITS play is off.

#### 1 Play a CD that you want to delete.

Press ▲ or ▼ to select a CD.

#### 2 Press FUNCTION and hold until TITLE IN appears in the display, then press FUNCTION to select ITS.

After TITLE IN is displayed, press FUNCTION until ITS appears in the display.

#### 3 Press ▼ to erase all tracks on the currently playing CD from your ITS playlist.

All tracks on the currently playing CD are erased from your playlist and ITS CLEAR is displayed.

#### 4 Press BAND to return to the playback display. □

## Using disc title functions

You can input CD titles and display the title. Then you can easily search for and select a desired disc for play.

### Entering disc titles

Disc title input lets you input CD titles up to 10 letters long and up to 100 disc titles (with ITS playlist) into the multi CD player.

#### 1 Play a CD that you want to enter the title.

Press ▲ or ▼ to select a CD.

#### 2 Press FUNCTION and hold until TITLE IN appears in the display.

After TITLE IN is displayed, press FUNCTION repeatedly, the following functions appear in the display:

**TITLE IN** (disc title input)—**ITS** (ITS programming)

■ When playing a CD TEXT disc on a CD TEXT compatible multi CD player, you cannot switch to **TITLE IN**. The disc title will have already been recorded on a CD TEXT disc.

#### 3 Press 1 numbered button to select the desired character type.

Press 1 numbered button repeatedly to switch between the following character type: Alphabet (upper case), numbers and symbols—Alphabet (lower case)

■ You can select to input numbers and symbols by pressing 2 numbered button.

#### 4 Press ▲ or ▼ to select a letter of the alphabet.

Each press of ▲ will display a letter of the alphabet in **A B C ... X Y Z**, numbers and symbols in **1 2 3 ... @ # <** order. Each press of ▼ will display a letter in the reverse order, such as **Z Y X ... C B A** order.

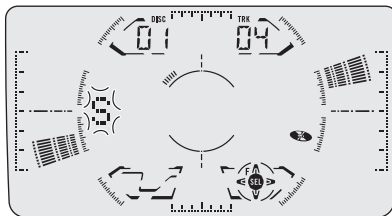

#### 5 Press ► to move the cursor to the next character position.

When the letter you want is displayed, press ► to move the cursor to the next position and then select the next letter. Press ◀ to move backwards in the display.

#### 6 Move the cursor to the last position by pressing ► after entering the title.

When you press ► one more time, the entered title is stored in memory.

**7 Press BAND to return to the playback display.**



### Notes

- Titles remain in memory, even after the disc has been removed from the magazine, and are recalled when the disc is reinserted.
- After data for 100 discs has been stored in memory, data for a new disc will overwrite the oldest one.

## Displaying disc titles

You can display the title of any disc that has had a disc title entered.

### ● Press DISPLAY.

Press **DISPLAY** repeatedly to switch between the following settings:

Play time—**DISC TITLE** (disc title)

When you select **DISC TITLE**, the title of the currently playing disc is shown in the display.

- If no title has been entered for the currently playing disc, **NO TITLE** is displayed.

## Selecting discs from the disc title list

Disc title list lets you see the list of disc titles that have been entered into the multi CD player and select one of them to playback.

### 1 Press FUNCTION to select TITLE LIST.

Press **FUNCTION** until **TITLE LIST** appears in the display.

### 2 Press ◀ or ▶ to scroll through the list of titles that have been entered.

- If no title has been entered for a disc, **NO TITLE** will be displayed.

### 3 Press ▲ to play your favorite CD title.

That selection will begin to play.

## Using CD TEXT functions

*You can use these functions only with a CD TEXT compatible multi CD player.*

Some discs have certain information encoded on the disc during manufacture. These discs may contain such information as the CD title, track title, artist's name and playback time and are called CD TEXT discs. Only these specially encoded CD TEXT discs support the functions listed below.

## Displaying titles on CD TEXT discs

### ● Press DISPLAY.

Press **DISPLAY** repeatedly to switch between the following settings:

Play time—**DISC TITLE** (disc title)—**D.ARTIST**

(disc artist name)—**TRK TITLE** (track title)

—**T.ARTIST** (track artist name)

- If specific information has not been recorded on a CD TEXT disc, **NO XXXX** will be displayed (e.g., **NO TA-NAME**).

## Scrolling titles in the display

This unit can display the first 10 letters only of **DISC TITLE**, **D.ARTIST**, **TRK TITLE** and **T.ARTIST**. When the recorded information is longer than 10 letters, you can scroll the text to the left so that the rest of the title can be seen.

### ● Press DISPLAY and hold until the title begins to scroll to the left.

The rest of the title will appear in the display.

## Multi-CD Player

### Using compression and bass emphasis

*You can use these functions only with a multi CD player that supports them.*

Using COMP (compression) and DBE (dynamic bass emphasis) functions let you adjust the sound playback quality of the multi CD player. Each of the functions have a two step adjustment. The COMP function balances the output of louder and softer sounds at higher volumes. DBE boosts bass levels to give playback a fuller sound. Listen to each of the effects as you select through them and use the one that best enhances the playback of the track or CD that you are listening to.

#### 1 Press FUNCTION to select COMP.

Press **FUNCTION** until **COMP** appears in the display.

- If the multi CD player does not support COMP/DBE, **NO COMP** is displayed when you attempt to select it.

#### 2 Press ▲ or ▼ to select your favorite setting.

Press ▲ or ▼ repeatedly to switch between the following settings:

**COMP OFF—COMP 1—COMP 2—**

**COMP OFF—DBE 1—DBE 2** 

## Introduction of audio adjustments

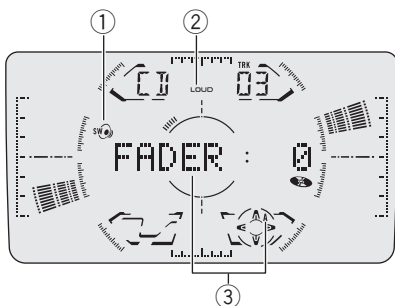

### ① SW indicator

Shows when the subwoofer output is turned on.

### ② LOUD indicator

Appears in the display when loudness is turned on.

### ③ Audio display

Shows the audio adjustments status.

### ● Press **AUDIO** to display the audio function names.

Press **AUDIO** repeatedly to switch between the following audio functions:

**FADER** (balance adjustment)—**LOUD** (loudness)—**SUB.W** (subwoofer)—**80Hz** (subwoofer setting)—**SLP** (subwoofer slope)—**F-HPF** (front high pass filter)—**R-HPF** (rear high pass filter)

- When the RCA output setting is **RCA:NON**, **SUB.W**, **80Hz** and **SLP** change to **NonFAD** (non fading) function.
- When the front high pass filter is turned on, you can select **F-SLP** (front high pass filter slope).
- When the rear high pass filter is turned on, you can select **R-SLP** (rear high pass filter slope).

- To return to the display of each source, press **BAND**.



### Note

If you do not operate the audio function within about 30 seconds, the display is automatically returned to the source display. □

## Using balance adjustment

You can select a fader/balance setting that provides an ideal listening environment in all occupied seats.

### 1 Press **AUDIO** to select **FADER**.

Press **AUDIO** until **FADER** appears in the display.

- If the balance setting has been previously adjusted, **BAL** will be displayed.

### 2 Press **▲** or **▼** to adjust front/rear speaker balance.

Each press of **▲** or **▼** moves the front/rear speaker balance towards the front or the rear. **FADER:F25 – FADER:R25** is displayed as the front/rear speaker balance moves from front to rear.

- **FADER:0** is the proper setting when only two speakers are used.

### 3 Press **◀** or **▶** to adjust left/right speaker balance.

When you press **◀** or **▶**, **BAL:0** is displayed. Each press of **◀** or **▶** moves the left/right speaker balance towards the left or the right. **BAL:L25 – BAL:R25** is displayed as the left/right speaker balance moves from left to right. □

## Audio Adjustments

### Adjusting loudness

Loudness compensates for deficiencies in the low and high sound ranges at low volume.

#### 1 Press **AUDIO** to select **LOUD**.

Press **AUDIO** until **LOUD** appears in the display.

#### 2 Press **▲** to turn loudness on.

**LOUD:ON** appears in the display.

#### 3 Press **▼** to turn loudness off.

**LOUD:OFF** appears in the display.



#### Note

You can also turn loudness on or off by pressing **LOUD**. 

### Using subwoofer output

This unit is equipped with a subwoofer output which can be turned on or off. When a subwoofer is controlled with this unit, first, switch the RCA output setting to subwoofer, then turn the subwoofer output on. For more details, see *Switching the RCA output setting* on page 37.

#### 1 Press **AUDIO** to select **SUB.W**.

Press **AUDIO** until **SUB.W** appears in the display.

- When the RCA output setting is **RCA:S/W**, you can select **SUB.W**.

#### 2 Press **▲** to turn subwoofer output on.

**SUB.W:ON** appears in the display. Subwoofer output is now on.

- To turn subwoofer output off, press **▼**.

#### 3 Press **◀** or **▶** to select the phase of subwoofer output.

Press **◀** to select reverse phase and **PHASE:REV** is displayed. Press **▶** to select normal phase and **PHASE:NOR** is displayed.

### Adjusting subwoofer (low pass filter) settings

When the subwoofer output is on, you can adjust just the cut off frequency and the output level of the subwoofer.

#### 1 Press **AUDIO** to select **80Hz**.

Press **AUDIO** until **80Hz** appears in the display.

- When the subwoofer output is on, you can select **80Hz**.
- If the subwoofer setting has been previously adjusted, the frequency of that previously selected will be displayed instead of **80Hz**.

#### 2 Press **◀** or **▶** to select cut-off frequency.

Each press of **◀** or **▶** selects cut off frequencies in the following order:

**50—63—80—100—125** (Hz)

Only frequencies lower than those in the selected range are output from the subwoofer.

#### 3 Press **▲** or **▼** to adjust the output level of the subwoofer.

Each press of **▲** or **▼** increases or decreases the level of the subwoofer. **+6—-24** is displayed as the level is increased or decreased.

### Adjusting low pass filter attenuation slope

When the subwoofer output is on, you can adjust just the continuity of sound between speaker units.

**1 Press AUDIO to select the slope setting.**

Press **AUDIO** until **SLP** appears in the display.

- When the subwoofer output is on, you can select **SLP**.

**2 Press ◀ or ▶ to select slope.**

Press ◀ and **12dB** is displayed. Press ▶ and **18dB** is displayed.

**Note**

When slope of subwoofer and high pass filter are **12dB**, and same cut off frequency, the phase is reversed 180 degrees at the cut off frequency. In this case, reversing the phase assures improved sound continuity. □

**Using the high pass filter**

When you do not want low sounds from the subwoofer output frequency range to play from the front or rear speakers, turn the HPF (high pass filter) on. Only frequencies higher than those in the selected range are output from the front or rear speakers. You can set up front and rear separately.

**1 Press AUDIO to select F-HPF or R-HPF.**

Press **AUDIO** until **F-HPF** or **R-HPF** appears in the display.

**2 Press ▲ to turn high pass filter on.**

**F-HPF 80Hz** or **R-HPF 80Hz** appears in the display. High pass filter is now on.

- To turn high pass filter off, press ▼.

**3 Press ◀ or ▶ to select cut-off frequency.**

Each press of ◀ or ▶ selects cut off frequencies in the following order:

**50—63—80—100—125** (Hz)

Only frequencies higher than those in the selected range are output from the front or rear speakers.

**Adjusting high pass filter attenuation slope**

When the high pass filter is on, you can adjust the continuity of sound between speaker units.

**1 Press AUDIO to select the slope setting.**

Press **AUDIO** until **F-SLP** or **R-SLP** appears in the display.

**2 Press ◀ or ▶ to select slope.**

Press ◀ and **12dB** is displayed. Press ▶ and **6dB** is displayed. □

**Using non fading output**

When the non fading output setting is on, the audio signal does not pass through this unit's low pass filter (for the subwoofer), but is output through the RCA output. For more details, see *Switching the RCA output setting* on page 37.

**1 Press AUDIO to select NonFAD.**

Press **AUDIO** until **NonFAD** appears in the display.

- When the RCA output setting is **RCA:NON**, you can select **NonFAD**.

**2 Press ▲ to turn non fading output on.**

**NonFAD:ON** appears in the display. Non fading output is now on.

- To turn non fading output off, press ▼.

**Adjusting non fading output level**

When the non fading output is on, you can adjust the level of non fading output.

## Audio Adjustments

### 1 Press **AUDIO** to select non fading output setting.

Press **AUDIO** until **NonFAD: 0** appears in the display.

### 2 Press **▲** or **▼** to adjust the level of the non fading output.

Each press of **▲** or **▼** increases or decreases the level of the non fading. **+6 – -24** is displayed as the level is increased or decreased. 

- Since the FM tuner volume is the control, it is not possible to apply source level adjustments to the FM tuner.
- The AM tuner volume level can also be adjusted with source level adjustments.
- The built in CD player and the multi CD player are set to the same source level adjustment volume automatically.
- External unit 1 and external unit 2 are set to the same source level adjustment volume automatically. 

## Adjusting source levels

SLA (source level adjustment) lets you adjust the volume level of each source to prevent radical changes in volume when switching between sources.

- Settings are based on the volume level of the FM tuner, which remains unchanged.

### 1 Compare the FM tuner volume level with the level of the source you wish to adjust.

### 2 Press **AUDIO** and hold until **SLA** appears in the display.

- When selecting the FM tuner as the source, you cannot switch to **SLA**.

### 3 Press **▲** or **▼** to adjust the source volume.

Each press of **▲** or **▼** increases or decreases the source volume.

**SLA :+4 – SLA :-4** is displayed as the source volume is increased or decreased.



#### Notes

- If you do not operate the SLA function within about 30 seconds, the display is automatically returned to the source display.

## Using the digital signal processor

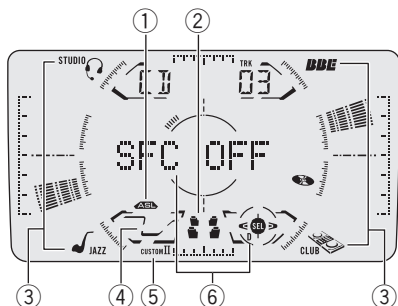

The digital signal processor lets you control many aspects of sound output including equalization, sound field control and listening position.

- ① **ASL indicator**  
Shows when the automatic sound levelizer is turned on.
- ② **Position indicator**  
Shows which listening position is currently selected.
- ③ **Sound field program indicator**  
Shows which sound field program is currently selected.
- ④ **Preset equalizer indicator**  
Shows which equalizer preset is currently selected.
- ⑤ **CUSTOM indicator**  
Shows when custom equalizer curve is currently selected.
- ⑥ **Function display**  
Shows the function status.

- **Press DSP to display the DSP function names.**

Press **DSP** repeatedly to switch between the following functions:

**SFC** (sound field control)—**POWER** (graphic equalizer)—**50Hz** (9 band graphic equalizer)—**POSI** (position selector)—**ASL** (automatic sound levelizer)

- To return to the display of each source, press **BAND**.



### Note

If you do not operate the DSP function within about 30 seconds, the display is automatically returned to the source display. 

## Using sound field control and BBE sound

SFC (sound field control) incorporate three programs for reproducing typical sound fields of a studio, jazz club or club. This function makes it possible to reproduce the realistic sound fields of the three programs in your car. With BBE, playback very close to the original sound can be obtained by correction with a combination of phase compensation and high range boost for the delay of the high frequency components and the amplitude deviation occurring during playback. This function makes it possible to reproduce the dynamic sound field as if you are listening to a live performance.



### Note

Manufactured under license from BBE Sound, Inc. The mark BBE is a trademark of BBE Sound, Inc.



## Digital Signal Processor

### Recalling sound field programs

Here is a list of the sound field programs:

Button	Display	Effect
1	STUDIO	Studio
2	JAZZ CLUB	Jazz club
3	CLUB	Club
4	BBE	BBE

#### 1 Press DSP to select the sound field control.

Press **DSP** until **SFC** appears in the display.

- If the sound field control has been previously set to a sound field program then the title of that previously selected sound field program will be displayed instead of **SFC**.

#### 2 Select a sound field program by pressing 1–4.

Select the desired sound field program by pressing one of the numbered buttons, from **1–4**, which correspond to the different sound field programs as listed above.

- You can also sequentially select a sound field program by pressing ◀ or ▶.

### Adjusting BBE sound level

With BBE sound processing technology, you can adjust the level of BBE.

#### 1 Recall BBE.

See *Recalling sound field programs* on this page.

#### 2 Press ▲ or ▼ to adjust the level of BBE.

Each press of ▲ or ▼ increases or decreases the level of BBE.

**+4 – –4** is displayed as the level is increased or decreased. 

### Using the graphic equalizer

The graphic equalizer lets you adjust the equalization to match car interior acoustic characteristics as desired.

### Recalling equalizer curves

There are seven stored equalizer curves which you can easily recall at any time. Here is a list of the equalizer curves:

Display	Equalizer curve
<b>S-BASS</b>	Super bass
<b>POWER</b>	Powerful
<b>NATURAL</b>	Natural
<b>VOCAL</b>	Vocal
<b>FLAT</b>	Flat
<b>CUSTOM1</b>	Custom 1
<b>CUSTOM2</b>	Custom 2

- **CUSTOM1** and **CUSTOM2** are adjusted equalizer curves that you create. Adjustments can be made with a 9 band graphic equalizer.
- When **FLAT** is selected no supplement or correction is made to the sound. This is useful to check the effect of the equalizer curves by switching alternatively between **FLAT** and a set equalizer curve.

#### 1 Press DSP to select the graphic equalizer.

Press **DSP** until **POWER** appears in the display.

- If the graphic equalizer has been previously set to an equalizer curve other than **POWER** then the title of that previously selected equalizer curve will be displayed instead of **POWER**.

## 2 Press ◀ or ▶ to select an equalizer curve.

Each press of ◀ or ▶ selects equalizer curves in the following order:

**S-BASS—POWER—NATURAL—VOCAL—FLAT—CUSTOM1—CUSTOM2**

## Adjusting equalizer curves

The factory supplied equalizer curves, with the exception of **FLAT**, can be adjusted to a fine degree (nuance control).

### 1 Recall an equalizer curve.

See *Recalling equalizer curves* on the previous page.

### 2 Press ▲ or ▼ to adjust the equalizer curve.

Each press of ▲ or ▼ increases or decreases the equalizer curve respectively.

**+6 – –5** (or **–6**) is displayed as the equalizer curve is increased or decreased.

- The actual range of the adjustments are different depending on which equalizer curve is selected.
- The equalizer curve with all frequencies set to **0** cannot be adjusted.

## Adjusting 9-band graphic equalizer

For **CUSTOM1** and **CUSTOM2** equalizer curves, you can adjust the level of each band.

- A separate **CUSTOM1** curve can be created for each source. (The built in CD player and the multi CD player are set to the same equalizer adjustment setting automatically.) If you make adjustments when a curve other than **CUSTOM2** is selected, the equalizer curve settings will be memorized in **CUSTOM1**.
- A **CUSTOM2** curve can be created common to all sources. If you make adjustments when the **CUSTOM2** curve is

selected, the **CUSTOM2** curve will be updated.

### 1 Recall the equalizer curve you want to adjust.

See *Recalling equalizer curves* on the previous page.

### 2 Press DSP to select 9-band graphic equalizer.

Press **DSP** until **50Hz** appears in the display.

- If 9 band graphic equalizer has been previously adjusted, the frequency of that previously selected will be displayed instead of **50Hz**.

### 3 Press ◀ or ▶ to select the equalizer band to adjust.

Each press of ◀ or ▶ selects equalizer bands in the following order:

**50—100—200—400—800—1.6 k—3.15 k—6.3 k—12.5 k** (Hz)

### 4 Press ▲ or ▼ to adjust the level of the equalizer band.

Each press of ▲ or ▼ increases or decreases the level of the equalization band.





**+6 – –6** is displayed as the level is increased or decreased.

- You can then select another band and adjust the level. □

## Using the position selector

One way to assure a more natural sound is to clearly position the stereo image, putting you right in the center of the sound field. The position selector adjusts the volume level of sound from each speaker to match seat positions and the number of people in the car and lets you recall settings at the touch of a button. Here is a list of the positions:

# Digital Signal Processor

Button	Display	Indicator	Position
▲	FRONT		Front seats
▼	ALL		All seats
◀	FRONT-L		Front seat left
▶	FRONT-R		Front seat right

## 1 Press DSP to select the position selector.

Press **DSP** until **POSI** appears in the display.

- If the position selector has been previously set to a listening position then the title of that previously selected listening position will be displayed instead of **POSI**.

## 2 Press ◀/▶/▲/▼ to select a listening position.

Press one of these, ◀/▶/▲/▼, to select a listening position as listed in the table.

- To cancel the selected listening position, press the same button again. ◻

## Using automatic sound levelizer

During driving, noise in the car changes according to the driving speed and road conditions. The automatic sound levelizer (ASL) monitors such varying noise and automatically increases the volume level, if this noise becomes greater. The sensitivity (variation of volume level to noise level) of ASL can be set to one of five levels.

## 1 Press DSP to select ASL.

Press **DSP** until **ASL** appears in the display.

## 2 Press ▲ to turn ASL on.

**ASL: MID** appears in the display.

- To turn ASL off, press ▼.

## 3 Press ◀ or ▶ to select the desired ASL level.

Each press of ◀ or ▶ selects ASL level in the following order:

**LOW** (low)—**MID-L** (mid low)—**MID** (mid)  
—**MID-H** (mid high)—**HIGH** (high) ◻

## Adjusting initial settings

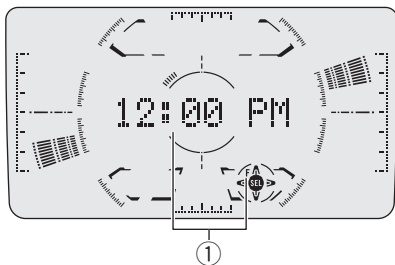

Initial settings lets you perform initial set up of different settings for this unit.

### ① Function display

Shows the function status.

**1 Press SOURCE upward or downward repeatedly until the unit turns off.**

**2 Press FUNCTION and hold until the clock appears in the display.**

**3 Press FUNCTION to select one of the initial settings.**

Press **FUNCTION** repeatedly to switch between the following settings:

Clock—**FM STEP** (FM tuning step)—**AM STEP** (AM tuning step)—**AUX** (auxiliary input)—**DIMMER** (dimmer)—**RCA** (RCA output)—**DIG.ATT** (digital attenuator)—**CONTRAST** (display contrast)—**MUTE** (telephone muting/attenuation)

Use the following instructions to operate each particular setting.

- To cancel initial settings, press **BAND**.
- You can also cancel initial settings by holding down **FUNCTION** until the unit turns off. 

## Setting the clock

Use these instructions to set the clock.

**1 Press FUNCTION to select clock.**

Press **FUNCTION** repeatedly until clock appears in the display.

**2 Press ◀ or ▶ to select the segment of the clock display you wish to set.**

Pressing ◀ or ▶ will select one segment of the clock display:

Hour—Minute

As you select segments of the clock display the segment selected will blink.

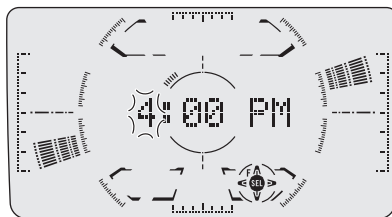

**3 Press ▲ or ▼ to set the clock.**

Pressing ▲ will increase the selected hour or minute. Pressing ▼ will decrease the selected hour or minute. 

## Setting the FM tuning step

The FM tuning step employed by seek tuning can be switched between 100 kHz, the preset step, and 50 kHz.

**1 Press FUNCTION to select FM STEP.**

Press **FUNCTION** repeatedly until **FM STEP** appears in the display.

**2 Press ◀ or ▶ to select the FM tuning step.**

Pressing ◀ or ▶ will switch the FM tuning step between 100 kHz and 50 kHz. The se

## Initial Settings

lected FM tuning step will appear in the display.

### Note

If seek tuning is performed in 50 kHz steps, stations may be tuned in imprecisely. Tune in the stations with manual tuning or use seek tuning again. 

## Setting the AM tuning step

The AM tuning step can be switched between 9 kHz, the preset step, and 10 kHz. When using the tuner in North, Central or South America, reset the tuning step from 9 kHz (531 – 1,602 kHz allowable) to 10 kHz (530 – 1,640 kHz allowable).

**1 Press FUNCTION to select AM STEP.**  
Press **FUNCTION** repeatedly until **AM STEP** appears in the display.

**2 Press ◀ or ▶ to select the AM tuning step.**  
Pressing ◀ or ▶ will switch the AM tuning step between 9 kHz and 10 kHz. The selected AM tuning step will appear in the display. 

## Switching the auxiliary setting

It is possible to use auxiliary equipment with this unit. Activate the auxiliary setting when using auxiliary equipment connected to this unit.

**1 Press FUNCTION to select AUX.**  
Press **FUNCTION** repeatedly until **AUX** appears in the display.

**2 Press ▲ or ▼ to turn AUX on or off.**  
Pressing ▲ or ▼ will turn **AUX** on or off and that status will be displayed (e.g., **AUX:ON**). 

## Switching the dimmer setting

To prevent the display from being too bright at night, the display is automatically dimmed when the car's headlights are turned on. You can switch dimmer on or off.

**1 Press FUNCTION to select DIMMER.**  
Press **FUNCTION** repeatedly until **DIMMER** appears in the display.

**2 Press ▲ or ▼ to turn DIMMER on or off.**  
Pressing ▲ or ▼ will turn **DIMMER** on or off and that status will be displayed (e.g., **DIMMER:ON**).

### Note

When you select **Custom** display color (refer to *Switching the display color* on page 39), the dimmer is not effective. 

## Switching the RCA output setting

This unit's RCA output can be used for sub woofer. You can select whether to use the sub woofer control (low pass filter) built in **RCA:S/W** or the auxiliary **RCA:NON**.

**1 Press FUNCTION to select RCA.**  
Press **FUNCTION** repeatedly until **RCA** appears in the display.

## 2 Press ◀ or ▶ to switch RCA output setting.

Pressing ◀ or ▶ will switch between **RCA :S/W** (subwoofer) and **RCA :NON** (non fading) and that status will be displayed.

## Selecting the digital attenuator

When listening to a CD or other source on which the recording level is high, setting the equalizer curve level to high may result in distortion. You can switch the digital attenuator to low to reduce distortion.

- Sound quality is better at the high setting so this setting is usually used.

### 1 Press FUNCTION to select DIG.ATT.

Press **FUNCTION** repeatedly until **DIG.ATT** appears in the display.

### 2 Press ◀ or ▶ to switch DIG.ATT high or low.

Pressing ◀ or ▶ will switch between **DIG.ATT: H** (high) and **DIG.ATT: L** (low) and that status will be displayed.

- When the source is Cassette player, the digital attenuator setting is fixed at Low.

## Adjusting display contrast

Display contrast adjustment lets you adjust the display for easier viewing when lighting conditions change.

### 1 Press FUNCTION to select CONTRAST.

Press **FUNCTION** repeatedly until **CONTRAST** appears in the display.

### 2 Press ◀ or ▶ to adjust the contrast.

Each press of ◀ or ▶ increases or decreases the contrast.

**+7** – **–7** is displayed as the contrast is increased or decreased.

## Switching the telephone muting/attenuation

Sound from this system is muted or attenuated automatically when a call is made or received using a cellular telephone connected to this unit.

- The sound turns off, **MUTE** or **ATT** is displayed and no audio adjustments, except volume control, are possible.
- Operation returns to normal when the phone call is ended.

### 1 Press FUNCTION to select MUTE.

Press **FUNCTION** repeatedly until **MUTE** appears in the display.

### 2 Press ◀ or ▶ to select the desired setting.

Each press of ◀ or ▶ selects settings in the following order:

**MUTE** (muting)— **–10dB ATT** (attenuation)—  
**–20dB ATT** (attenuation)  
**–20dB ATT** has a stronger effect than  
**–10dB ATT**.

## Other Functions

### Turning the clock display on or off

You can turn the clock display on or off.

- **Press LOUD and hold until the clock appears in the display.**

- To turn off the clock display, press **LOUD** and hold until the clock disappears from the display.
- The clock display disappears temporarily when you perform other operations, but the clock display appears again after 25 seconds.



#### Note

Even when the sources are off, the clock display appears on the display. 

### Switching the display color

You can change the display color.

- **Press COLOR.**

Each time you press **COLOR** the color changes in the following order:

**Rainbow** (default)—**Aurora**—**WhiteBlue**—**OceanBlue**—**DeepBlue**—**Aquamarine**—**LeafGreen**—**PureYellow**—**PaleOrange**—**CyberRed**—**ActivePink**—**CoolViolet**—**Custom**



#### Notes

- When you select **Rainbow**, the color changes continuously in the above order.
- When you select **Aurora**, the color changes according to sound.
- **Custom** is an adjusted color that you create.

### Adjusting the display color

Setting up of a color is performed by adjusting the level of three colors such as red, green and blue.

- 1 **Press COLOR and hold until Red appears in the display.**

- 2 **Press ◀ or ▶ to select the color to adjust.**

Each press of ◀ or ▶ selects colors in the following order:

**Red** (red)—**Green** (green)—**Blue** (blue)

- 3 **Press ▲ or ▼ to adjust the level of color.**

Each press of ▲ or ▼ increases or decreases the level of color.

**4 – 0** is displayed as the level is increased or decreased.

- 4 **Press BAND to return to the playback display.** 

### Using different entertainment displays

You can enjoy entertainment displays while listening to each sound source.

- These are different ways of displaying the spectrum and do not affect sound output.

- **Press ENTERTAINMENT.**

Each time you press **ENTERTAINMENT** the display changes in the following order:

Dynamic (default)—Hyper wave—Oscilloscope—Lock on rader—**ASL Effect**—Silent—Volcano—Symmetry 

### Using the AUX source

An IP BUS RCA Interconnector such as the CD RB20/CD RB10 (sold separately) lets you connect this unit to auxiliary equipment featuring RCA output. For more details, refer to the IP BUS RCA Interconnector owner's manual.

## Selecting AUX as the source

- Press **SOURCE** upward or downward to select **AUX** as the source.

Press **SOURCE** until **AUX** appears in the display.

- If the auxiliary setting is not turned on, **AUX** cannot be selected. For more details, see *Switching the auxiliary setting* on page 37.

## Setting the AUX title

The title displayed for the **AUX** source can be changed.

- 1 After you have selected **AUX** as the source, press **FUNCTION** and hold until **TITLE IN** appears in the display.

- 2 Press **1** numbered button repeatedly to select the desired character type.

Press **1** numbered button repeatedly to switch between the following character type:

Alphabet (upper case), numbers and symbols  
—Alphabet (lower case)

- You can select to input numbers and symbols by pressing **2** numbered button.

- 3 Press **▲** or **▼** to select a letter of the alphabet.

Each press of **▲** will display a letter of the alphabet in **A B C ... X Y Z**, numbers and symbols in **1 2 3 ... @ # <** order. Each press of **▼** will display a letter in the reverse order, such as **Z Y X ... C B A** order.

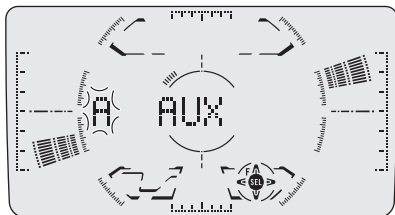

- 4 Press **▶** to move the cursor to the next character position.

When the letter you want is displayed, press **▶** to move the cursor to the next position and then select the next letter. Press **◀** to move backwards in the display.

- 5 Move the cursor to the last position by pressing **▶** after entering the title.

When you press **▶** one more time, the entered title is stored in memory.

- 6 Press **BAND** to return to the playback display. 



## Additional Information

### Understanding built-in CD player error messages

When problems occur during CD play an error message may appear on the display. If an error message appears on the display refer to the table below to see what the problem is and the suggested method of correcting the problem. If the error cannot be corrected, contact your dealer or your nearest Pioneer Service Center.

Message	Cause	Action
<b>CD ERR-11, 12, 17, 30</b>	Dirty disc	Clean disc.
<b>CD ERR-11, 12, 17, 30</b>	Scratched disc	Replace disc.
<b>CD ERR-14</b>	Blank disc	Check the disc.
<b>CD ERR-10, 11, 12, 14, 17, 30, A0</b>	Electrical or mechanical	Turn the ignition ON and OFF, or switch to a different source, then back to the CD player.
<b>CD ERR-44</b>	All tracks are skip tracks	Replace disc.



### Cassette tapes

- A loose, torn or warped label on a cassette tape can jam the cassette player. Do not use cassette tapes with loose, torn or warped labels.
- Cassette tapes longer than C 90 (90 minute tapes) can cause the tape to jam in the cassette player. Do not use tapes longer than C 90.

- Cassette tapes exposed to high temperatures may warp and jam the cassette player. Keep cassettes out of direct sunlight or places where there are high temperatures.



- Store unused tapes in a tape case where there is no danger of them becoming loose, dirty or dusty.

### Cleaning the playback head

If the head becomes dirty, the sound quality will get bad and there will be sound dropouts and other problems. If you have any of these problems the head may need cleaning.

### Music search and repeat functions during tape playback

Music search and repeat functions may not work with these tapes:

- A tape with a gap of 4 seconds or less between songs
- A tape containing dialog or other non musical content, with pauses lasting 4 seconds or longer
- A tape with an extremely quiet passage in the music lasting for 4 seconds or longer

## Additional Information

### CD player and care

- Use only CDs that have either of the two Compact Disc Digital Audio marks as shown below.



- Use only normal, round CDs. If you insert irregular, non round, shaped CDs they may jam in the CD player or not play properly.

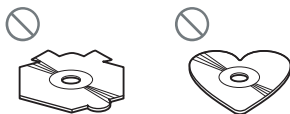

- Check all CDs for cracks, scratches or warped discs before playing. CDs that have cracks, scratches or are warped may not play properly. Do not use such discs.
- Avoid touching the recorded (non printed side) surface when handling the disc.
- Store discs in their cases when not in use.
- Keep discs out of direct sunlight and do not expose the discs to high temperatures.
- Do not attach labels, write on or apply chemicals to the surface of the discs.
- To clean dirt from a CD, wipe the disc with a soft cloth outward from the center of the disc.



- If the heater is used in cold weather, moisture may form on components inside the CD player. Condensation may cause the CD player to not operate properly. If you think that condensation is a problem turn off the CD player for an hour or so to allow the CD

player to dry out and wipe any damp discs with a soft cloth to remove the moisture.

- Road shocks may interrupt CD playback. ■

### CD-R/CD-RW discs

- When CD R/CD RW discs are used, playback is possible only for discs which have been finalized.
- It may not be possible to play back CD R/CD RW discs recorded on a music CD recorder or a personal computer because of disc characteristics, scratches or dirt on the disc, or dirt, condensation, etc. on the lens of this unit.
- Playback of discs recorded on a personal computer may not be possible depending on the application settings and the environment. Please record with the correct format. (For details, contact the manufacturer of the application.)
- Playback of CD R/CD RW discs may become impossible in case of direct exposure to sunlight, high temperatures, or the storage conditions in the car.
- Titles and other text information recorded on a CD R/CD RW disc may not be displayed by this unit (in the case of audio data (CD DA)).
- This unit conforms to the track skip function of the CD R/CD RW disc. The tracks containing the track skip information are skipped automatically (in case of audio data (CD DA)).
- If you insert a CD RW disc into this unit, time to playback will be longer than when you insert a conventional CD or CD R disc.
- Read the precautions with CD R/CD RW discs before using them. ■

# Additional Information

## Specifications

### General

Rated power source .....	14.4 V DC (allowable voltage range: 12.0 – 14.4 V DC)
Grounding system .....	Negative type
Max. current consumption .....	10.0 A
Dimensions (W × H × D):	
Chassis .....	178 × 100 × 160 mm
Nose .....	169 × 94 × 15 mm
Weight .....	2.5 kg

### Audio/DSP

Continuous power output is 22 W per channel minimum into 4 ohms, both channels driven 50 to 15,000 Hz with no more than 5% THD.

Maximum power output .....	50 W × 4
Load impedance .....	4 Ω (4 – 8 Ω allowable)
Preout max output level/output impedance .....	1.8 V/1 kΩ
Loudness contour .....	+10 dB (100 Hz), +7 dB (10 kHz) (volume: –30 dB)
Equalizer (9 Band Graphic Equalizer):	
Frequency .....	50/100/200/400/800 Hz 1.6/3.15/6.3/12.5 kHz
Equalization range .....	±12 dB

#### Network:

HPF (Front/rear):	
Frequency .....	50/63/80/100/125 Hz
Slope .....	–6 dB/oct, –12 dB/oct
Subwoofer:	
Frequency .....	50/63/80/100/125 Hz
Slope .....	–12 dB/oct, –18 dB/oct
Gain .....	+6 – –24 dB
Phase .....	Normal/Reverse

### CD player

System .....	Compact disc audio system
Usable discs .....	Compact disc
Signal format:	
Sampling frequency .....	44.1 kHz
Number of quantization bits .....	16; linear
Frequency characteristics .....	5 – 20,000 Hz (±1 dB)
Signal to noise ratio .....	94 dB (1 kHz) (IEC A network)
Dynamic range .....	92 dB (1 kHz)
Number of channels .....	2 (stereo)

### Cassette player

Tape .....	Compact cassette tape (C 30 – C 90)
Tape speed .....	4.8 cm/sec
Fast forward/rewinding time .....	Approx. 100 sec (C 60)
Wow & flutter .....	0.09 % (WRMS)
Frequency response:	
Metal .....	30 – 19,000 Hz (±3 dB)
Stereo separation .....	45 dB
Signal to noise ratio:	
Metal:	
Dolby B NR IN .....	67 dB (IEC A network)
Dolby NR OUT .....	61 dB (IEC A network)

### FM tuner

Frequency range .....	87.5 – 108.0 MHz
Usable sensitivity .....	8 dBf (0.7 μV/75 Ω mono, S/N: 30 dB)
50 dB quieting sensitivity .....	10 dBf (0.9 μV/75 Ω mono)
Signal to noise ratio .....	75 dB (IEC A network)
Distortion .....	0.3 % (at 65 dBf, 1 kHz, stereo) 0.1 % (at 65 dBf, 1 kHz, mono)
Frequency response .....	30 – 15,000 Hz (±3 dB)
Stereo separation .....	45 dB (at 65 dBf, 1 kHz)

### AM tuner

Frequency range .....	531 – 1,602 kHz (9 kHz) 530 – 1,640 kHz (10 kHz)
Usable sensitivity .....	18 μV (S/N: 20 dB)
Signal to noise ratio .....	65 dB (IEC A network)

### Infrared remote control

Wavelength .....	940 nm ±50 nm
Output .....	typ; 12 mw/sr per Infrared LED



#### Note

Specifications and the design are subject to possible modifications without notice due to improvements. □

**PIONEER CORPORATION**

4-1, MEGURO 1-CHOME, MEGURO-KU, TOKYO 153-8654, JAPAN

**PIONEER ELECTRONICS (USA) INC.**

P.O. Box 1540, Long Beach, California 90801-1540, U.S.A.  
TEL: (800) 421-1404

**PIONEER EUROPE NV**

Haven 1087, Keetberglaan 1, B-9120 Melsele, Belgium  
TEL: (0) 3/570.05.11

**PIONEER ELECTRONICS ASIACENTRE PTE. LTD.**

253 Alexandra Road, #04-01, Singapore 159936  
TEL: 65-6472-1111

**PIONEER ELECTRONICS AUSTRALIA PTY. LTD.**

178-184 Boundary Road, Braeside, Victoria 3195, Australia  
TEL: (03) 9586-6300

**PIONEER ELECTRONICS OF CANADA, INC.**

300 Allstate Parkway, Markham, Ontario L3R OP2, Canada  
TEL: (905) 479-4411

**PIONEER ELECTRONICS DE MEXICO, S.A. de C.V.**

Bldv.Manuel Avila Camacho 138 10 piso  
Col.Lomas de Chapultepec, Mexico, D.F. 11000  
TEL: 55-9178-4270

Published by Pioneer Corporation.  
Copyright © 2002 by Pioneer Corporation.  
All rights reserved.

Printed in Thailand

<CRD3750-A/N> ES

<KYMZX/02L00000>